

Article number: 20165B252SW

Description: E+G

Base plate clamp GN165-B25-2-SW

## Measures

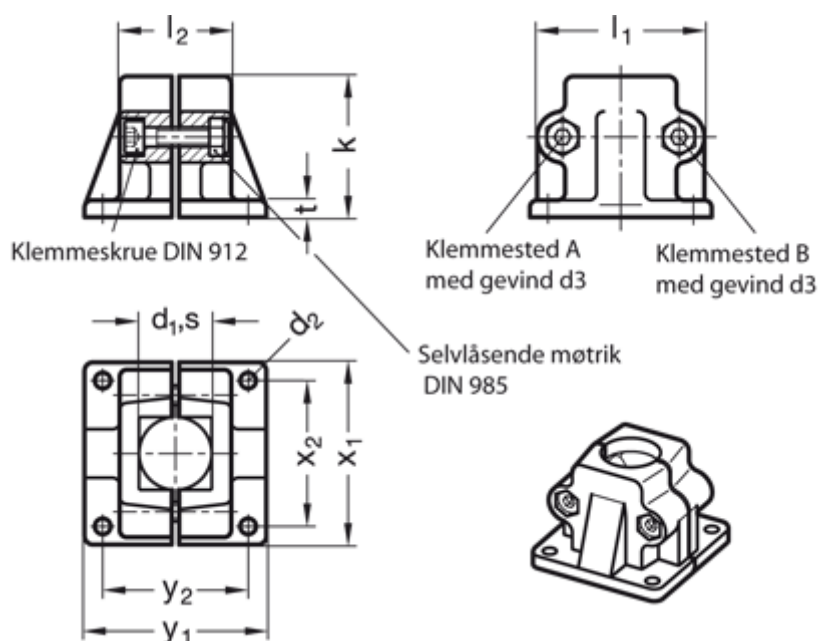

Adjustable clamp lever = GN 911-M8-40 have to be ordered separately

d1	= B30
d2	= 7
d3	= M 8
k	= 58
l1	= 69
l2	= 46
t	= 7

x1 = 75
x2 = 60
y1 = 75
y2 = 60